

### Step 4

After all upper leg attachment are in place, screws the foot in counterclockwise on all 4.

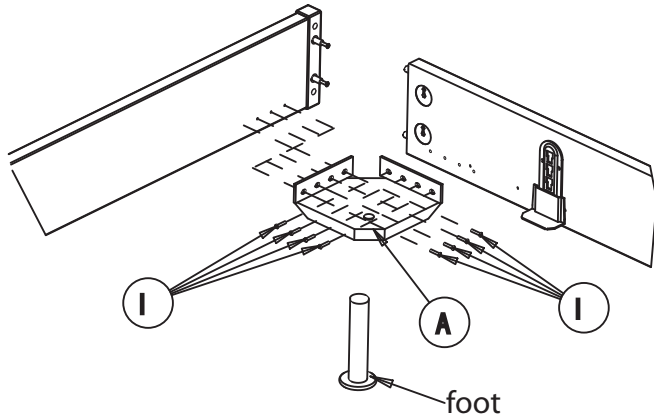

### Step 7

\*\* If using an AxelBloom bedframe:

Use a flat head screwdriver to remove the protective rubber ends on bed slat.

Place slat bed base on the support clips & center beam.

Note: No screws are needed to be used to attach slat bed base to bed frame.

If you have an adjustable foot and head section, attach the mattress foot and side stopper.

### Step 8

Place mattress on slat bed bases. Either sides are acceptable, except for the DW600 & the Austroflex.

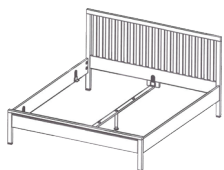

scaleo

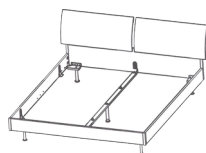

varo

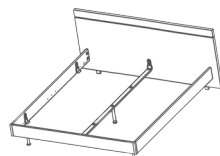

luma/legra

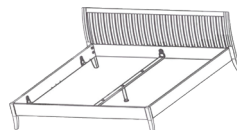

piolo

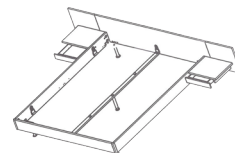

casa

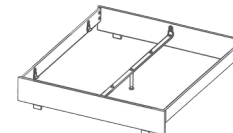

piedi

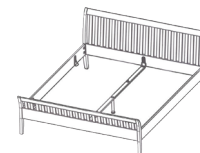

alora

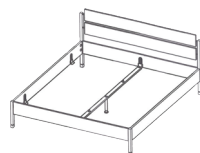

linus

### Step 5

Attach all support clip (bracket) to frame and select appropriate height

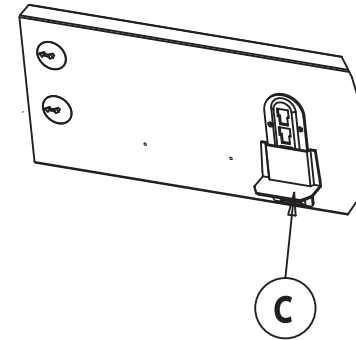

### Step 6

Follow Center Beam with Foot Assembly Page to assemble center beam and attach to frame.

